















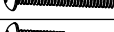









A		M8	20 pcs
B1		M8	6 pcs
B2		M8	14 pcs
C		M8	2 pcs
D		M8*45	4 pcs
E		M8*20	2 pcs
F		M8*35	6 pcs
G		M8*30	8 pcs
H		M8*50	8 pcs
J		M8	14 pcs
K			6 pcs
L			1 pc
M			1 pc
N			4 pcs
P			6 pcs
Q		30*30*1430	2 pcs
R		13-13	1 pc
S		5mm	1 pc
T			1 pc
U			1 pc
V			2 pcs
W			1 pc
X			2 pcs
Y			2 pcs

1

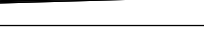

2

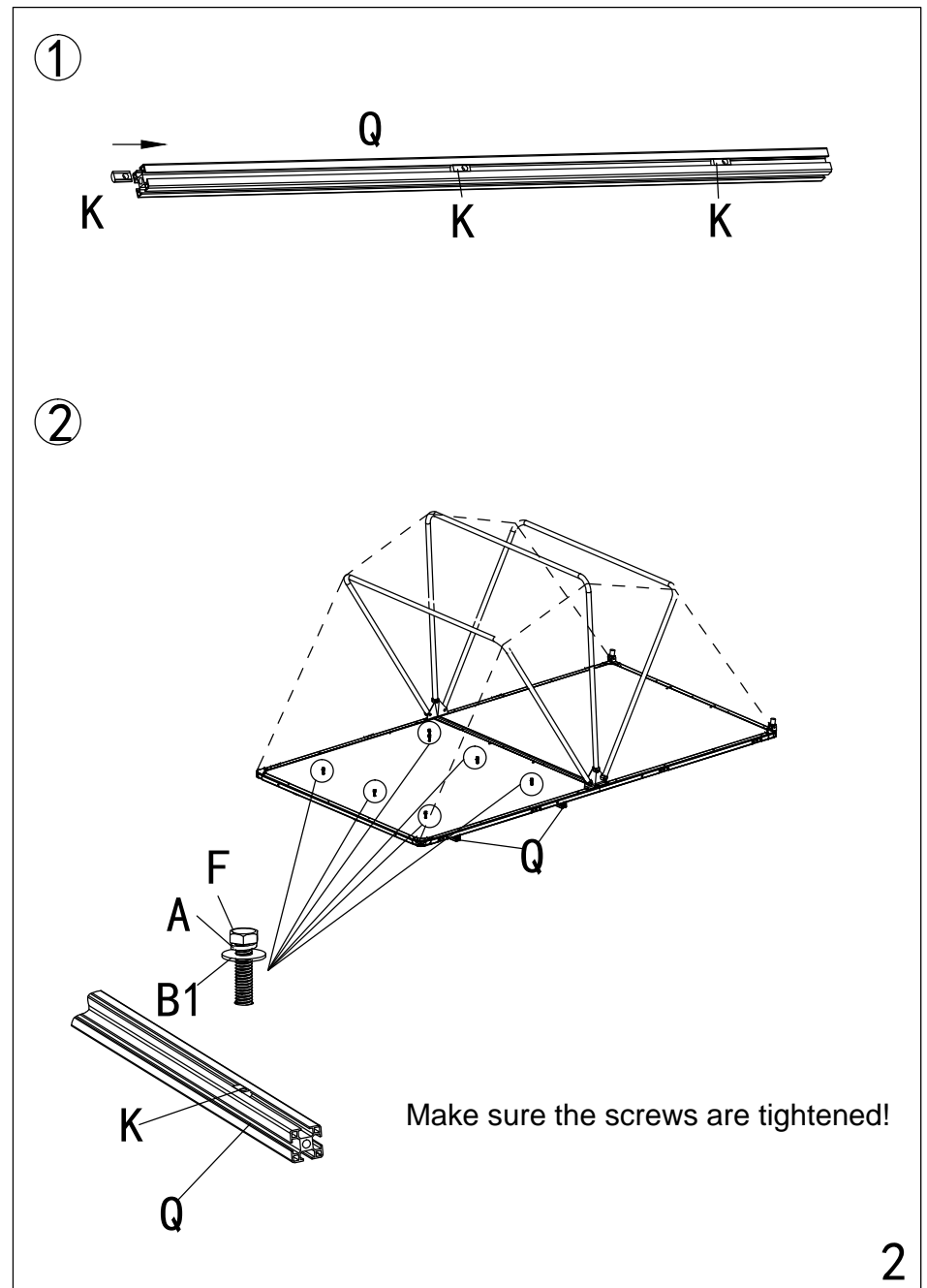
3

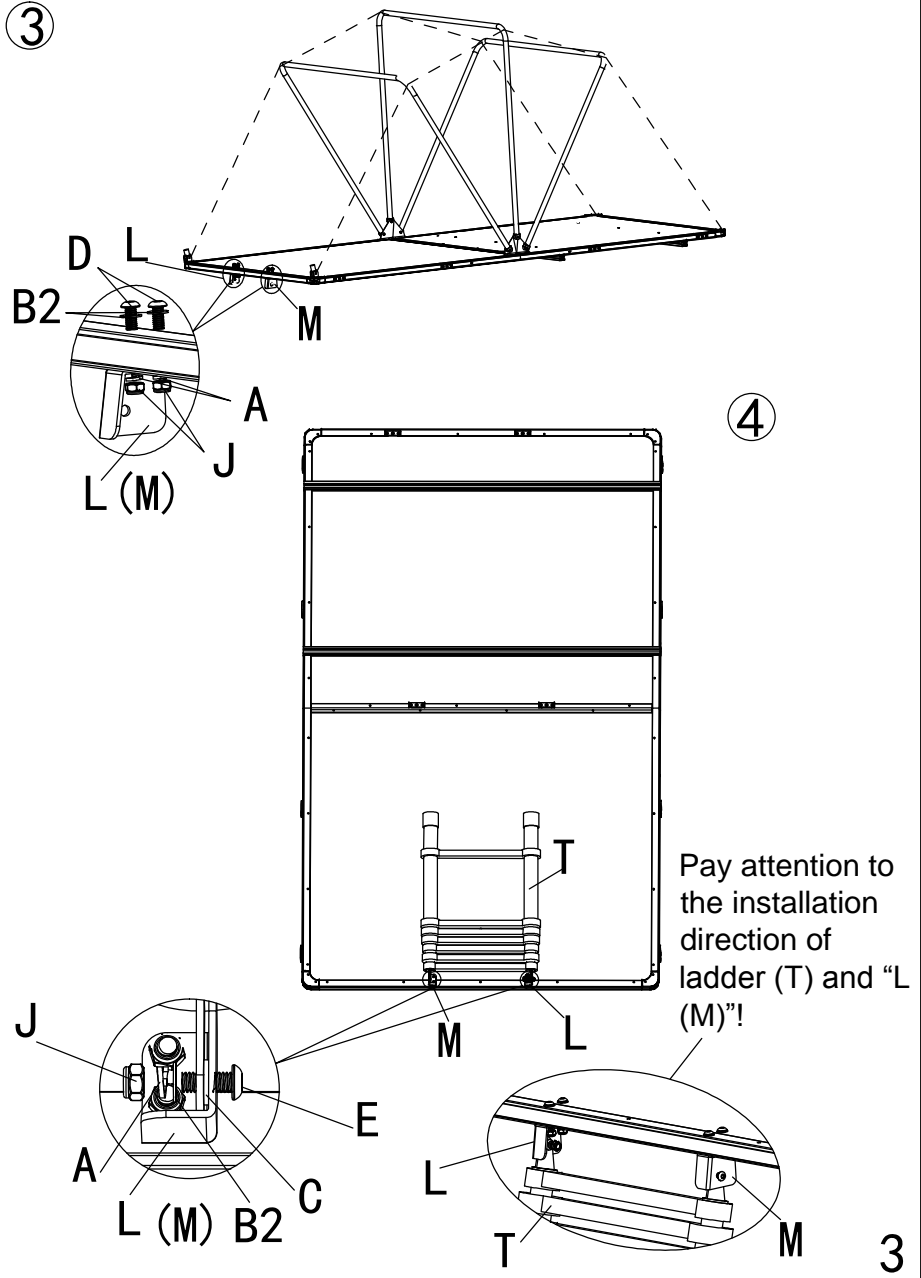

5

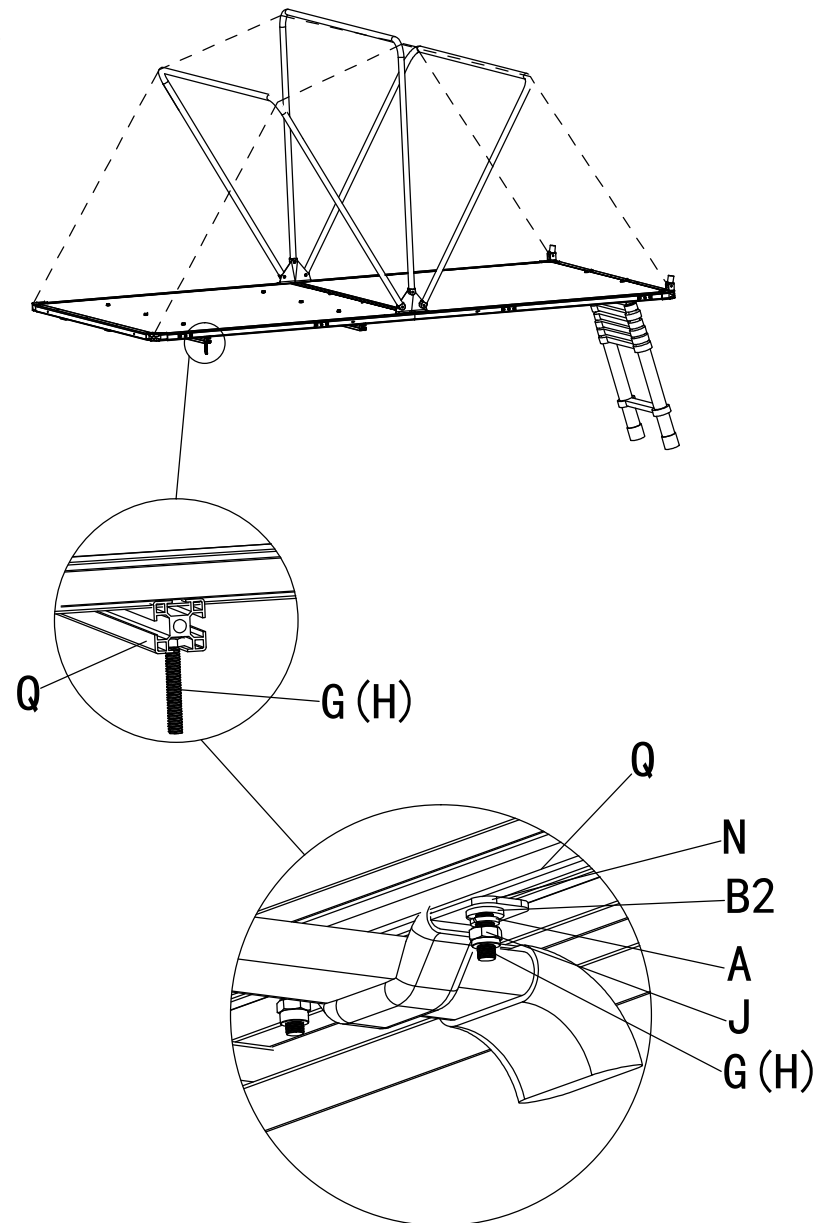

Make sure the screws are tightened!

6

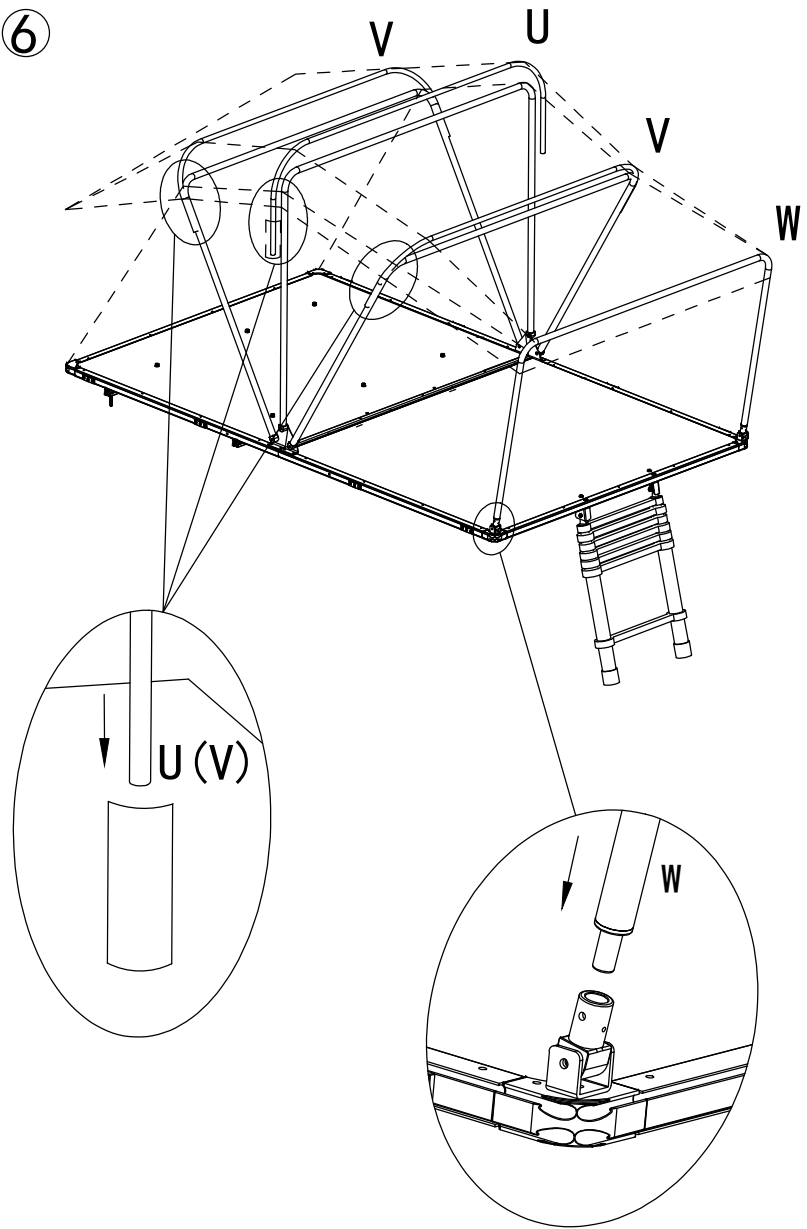

5

7

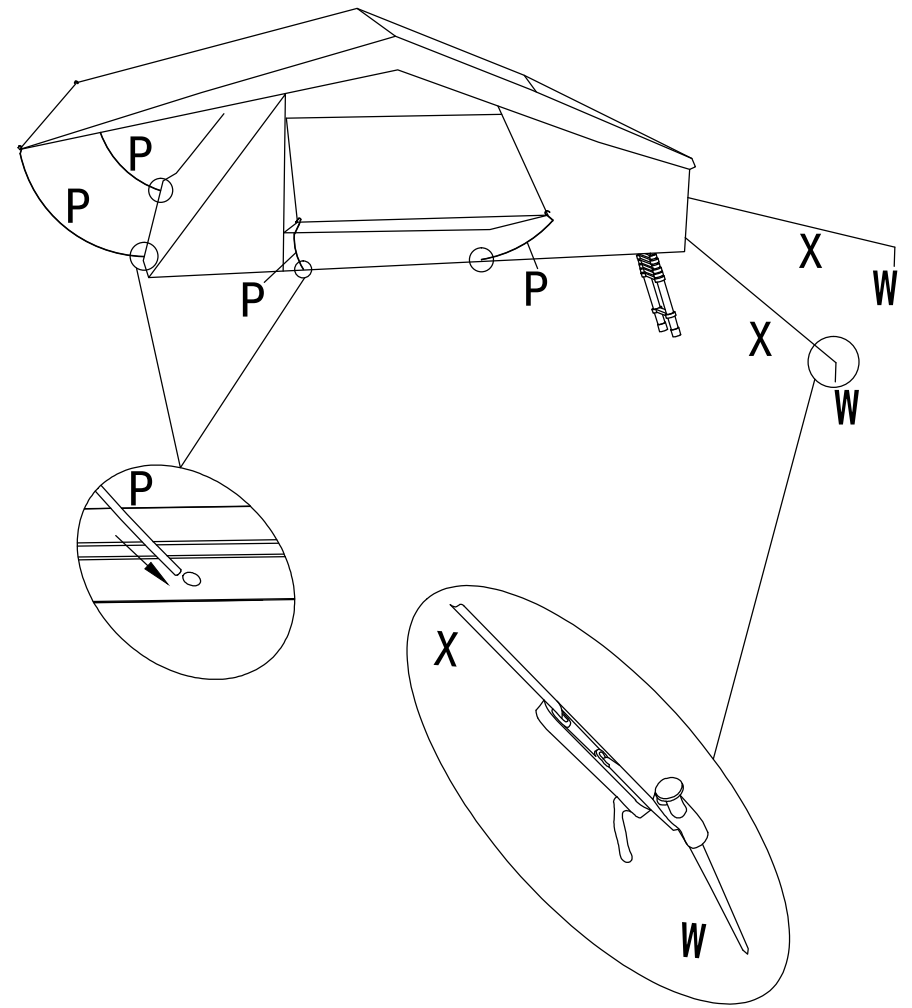

6